

F20700/V

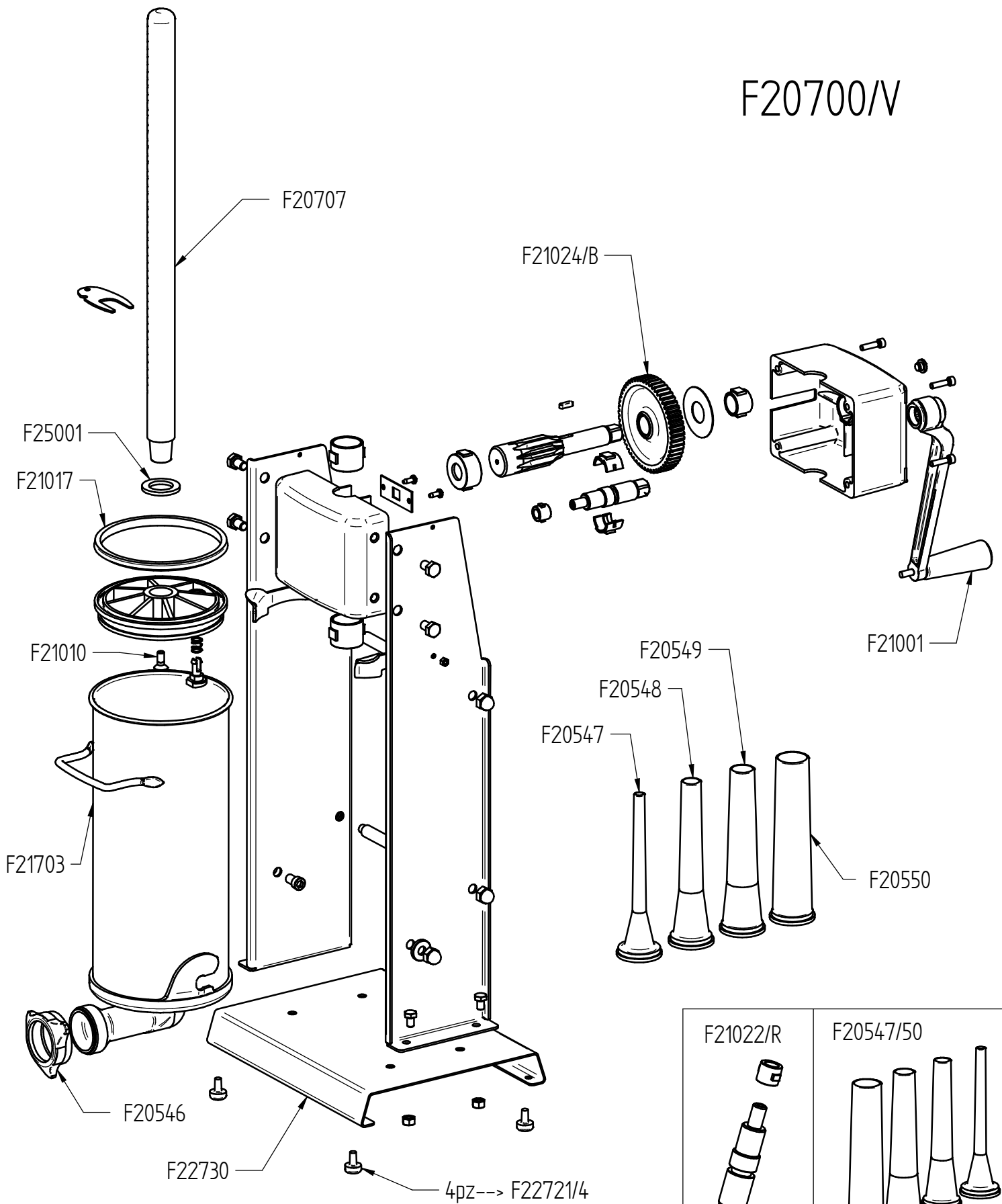

F21022/R

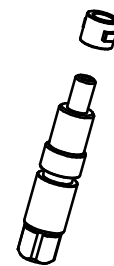

F20547/50

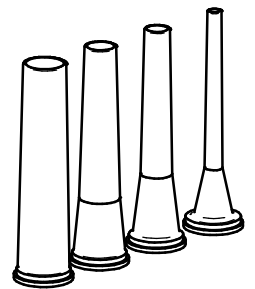

F20526/I

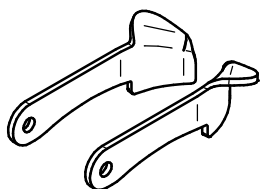

F21049

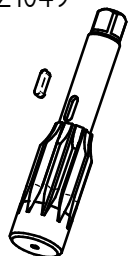

F22571

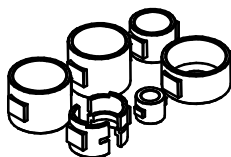

F21080/VB

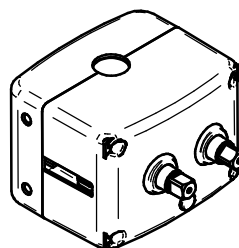

F20630



F21008

